

Features

● Multi-circuit and Compact design

Although this connector is multi-circuit, the miniaturization and low profile are realized by unification of frontage and 2.0mm pitch.

● Terminal construction

By having given a spring structure to the male terminal, the female terminal can be made into a simple box shape structure.

Developed in pursuit of multi-circuit, miniaturization and low profile as PC board connector for automobile.
This connector is dip type connector having the spring structure on male terminal.

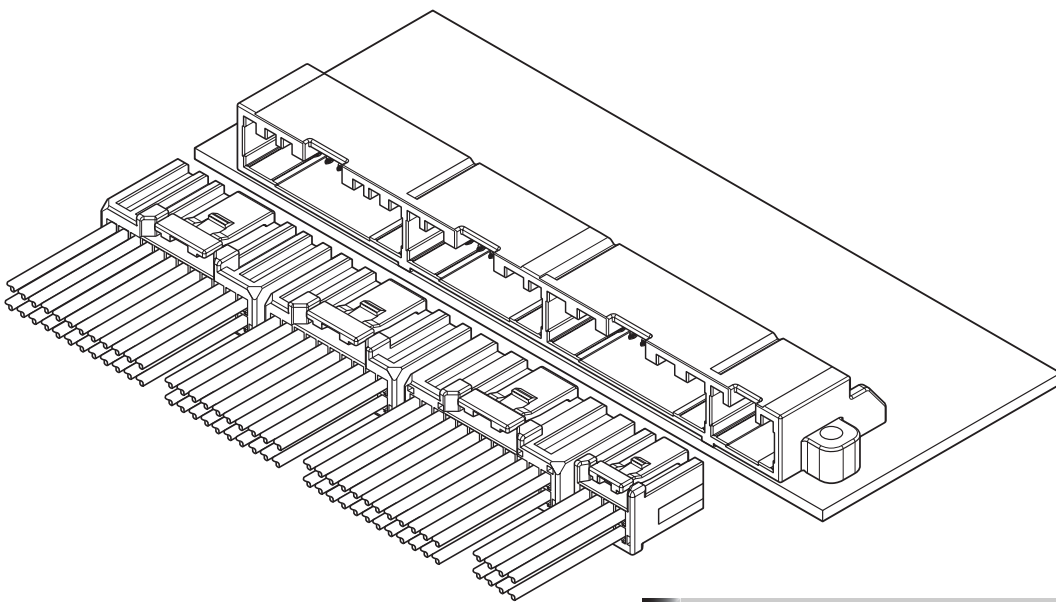

Specifications

- Current rating: 3 A AC, DC (0.3 mm², Single circuit)
- Voltage rating: 50 V AC, DC
- Temperature range: -40°C to +100°C
(including temperature rise in applying electrical current)
- Contact resistance: Initial value/ 8 mΩ max.
After environmental tests/ 16 mΩ max.
- Insulation resistance: 100 MΩ min.
- Withstanding voltage: 1,000 VAC/minute
- Applicable wire: AESSX-f/ AVSS
0.3 mm² (AWG #22)

* Compliant with ELV/RoHS.
* Contact JST for details.

Female terminal

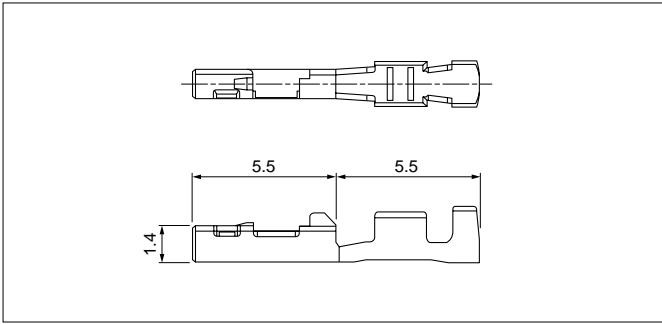

Model No.	Applicable wire range		Q'ty/reel
	Conductor (mm ²)	Insulation O.D. (mm)	
SCPT-A021GF-0.5	0.3	1.4	15,000

Material and Finish

Brass, nickel-undercoated, Contact area; gold-plated
Barrel area; tin-plated

Female connector

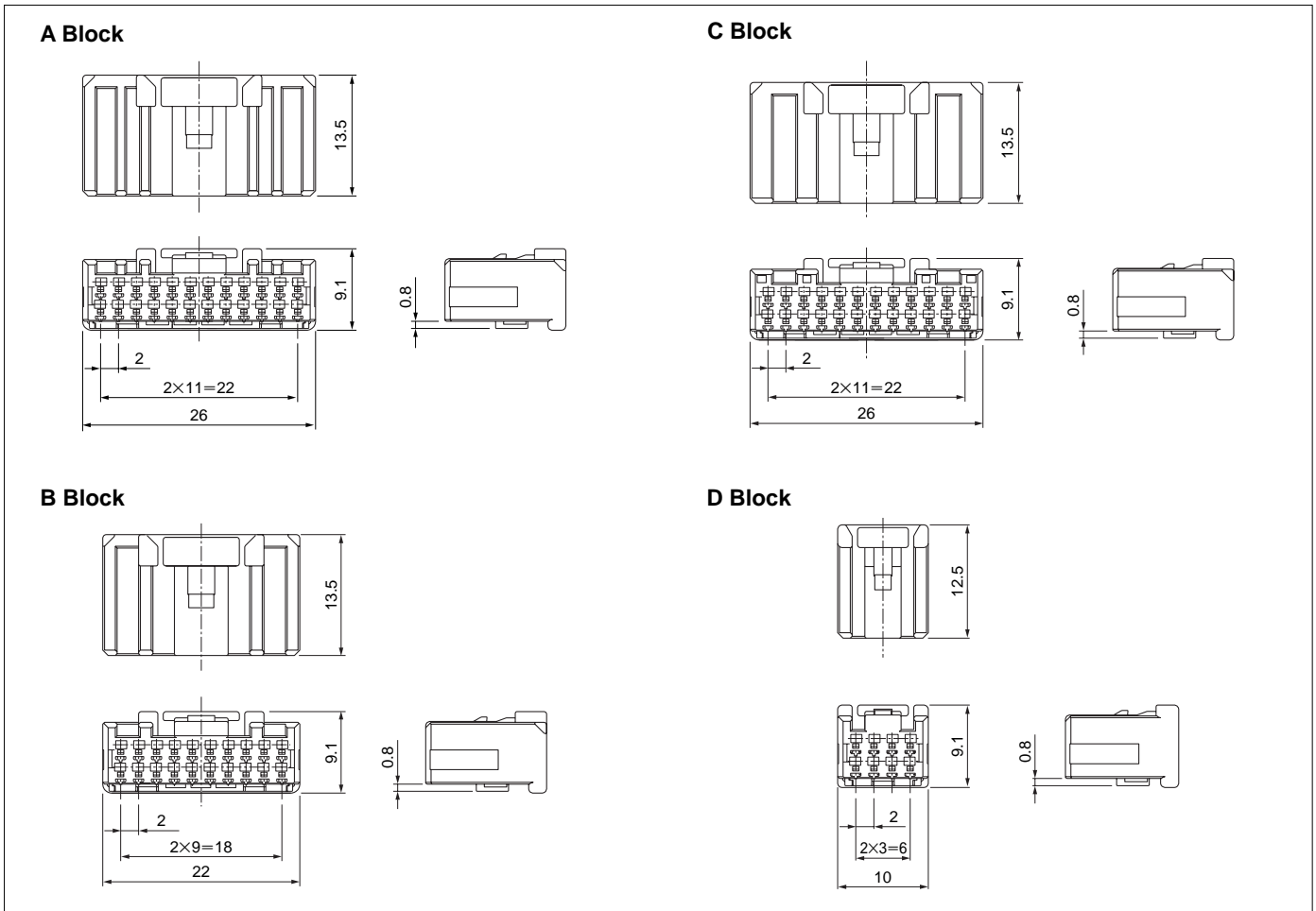

Type	Circuits	Model No.	Q'ty/box
A Block	24	24CPT-B-2B	200
B Block	20	20CPT-B-2A	250
C Block	24	24CPT-B-2A	200
D Block	8	08CPT-B-2A	500

Material

Housing: Glass-filled PBT, black
Retainer: Glass-filled PBT, blue

CPI CONNECTOR

Male connector

• 58 circuits

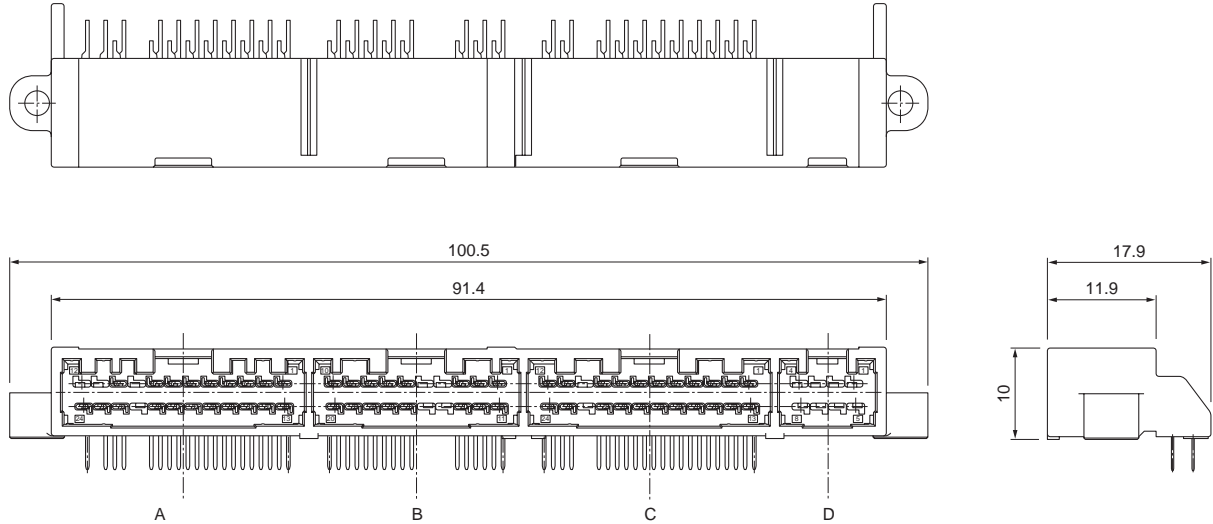

• 69 circuits

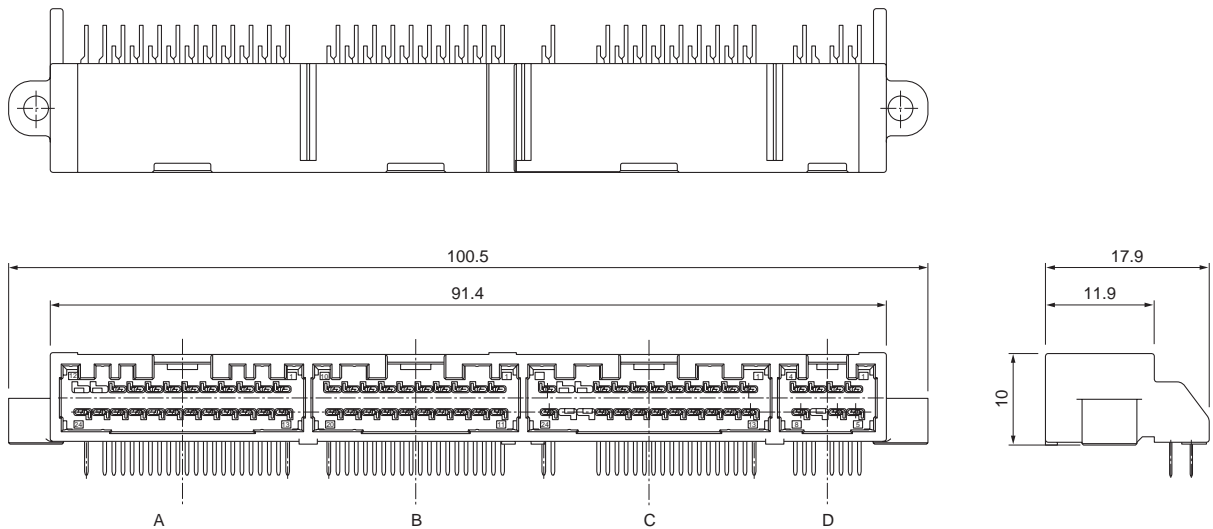

Circuits	Model No.	Q'ty/box
58	S58-CPIK-1A (M)	450
69	S69-CPIK-1A (M)	450
Material and Finish		
Terminal: Copper alloy, nickel-undercoated, Contact area; gold-plated Solder tail; tin-plated (reflow treatment)		
Housing: Glass-filled SPS, black		

PC board layout

• 58 circuits

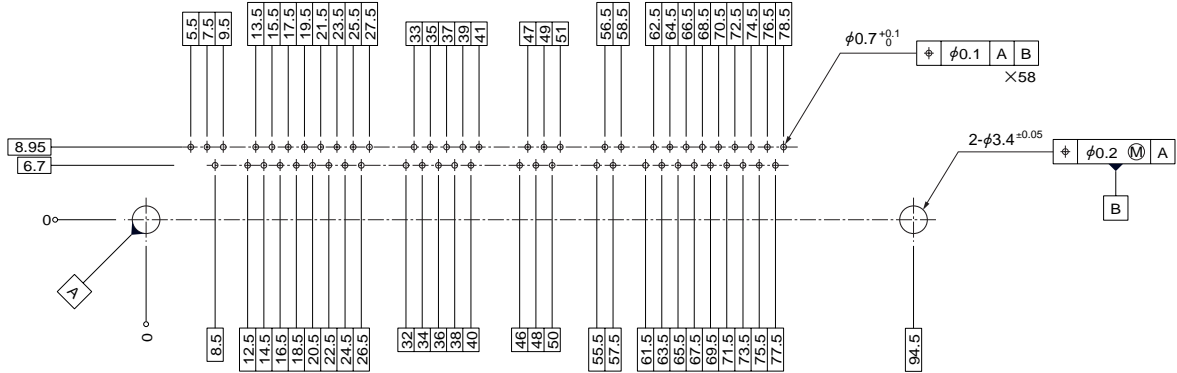

• 69 circuits

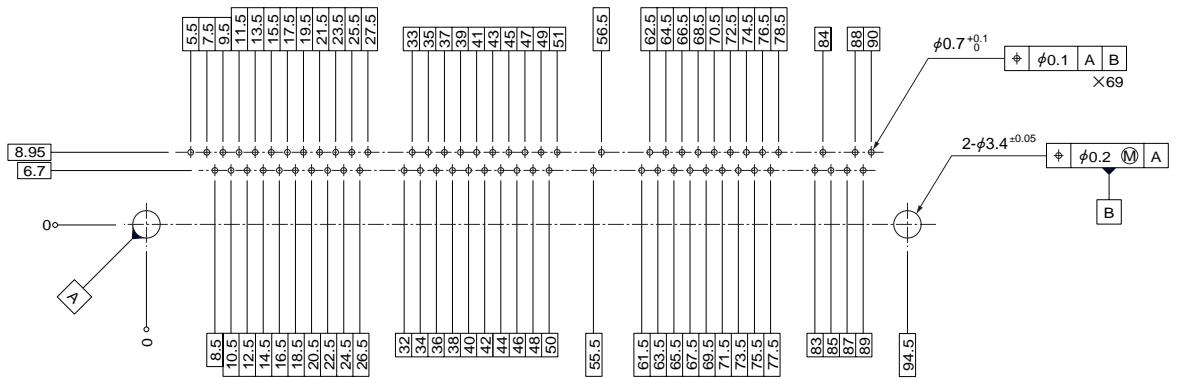

Note: 1. Tolerances are non-cumulative.

2. Hole dimensions differ according to the type of PC board and piercing method.
The dimensions above should serve as guideline. Contact JST for details.

Crimping machine, Applicator

Strip terminal	Crimping machine	Crimp applicator MKS-L	
		Dies	Crimp applicator with dies
SCPT-A021GF-0.5	AP-K2N	MK/SCPT-A021-05	APLMK SCPT-A021-05

Note: When crimping operation is conducted using an applicator and die set other than the above, JST cannot guarantee the performance of the terminal.